

Zen SS316L Toilet Roll Holder

Nero

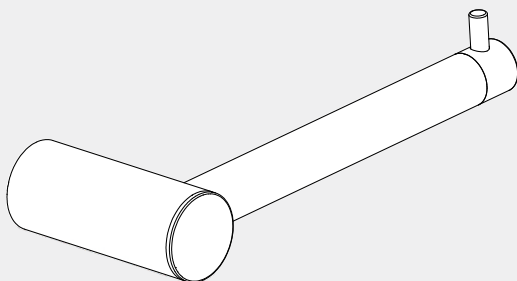

Versions:202405

25 YEARS WARRANTY
25
25 YEARS WARRANTY

Drawing

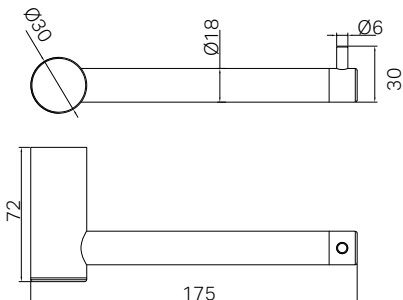

Features

- 316L grade stainless steel construction for durability
- Easy to install

Packaging Includes

1x Toilet Roll Holder

Finish & SKU

Brushed Bronze
NR1686BZ

Graphite
NR1686GR

Brushed Gold
NR1686BG

Brushed Nickel
NR1686BN

*Dimensions are nominal measurements only.

GENERAL PRECAUTIONS AND WARNINGS

- Before installation, make sure the wall surface is clean and dry to ensure a secure attachment.
- When tightening screws, do not apply excessive force to prevent damage to the wall or the fixtures.
- Use the correct tools: a drill with a 6mm bit, screwdriver, and level.
- Wear appropriate safety gear, such as gloves and safety glasses, to protect yourself during installation.
- Before drilling, check the wall for any hidden pipes or electrical wires to avoid accidental damage.
- Ensure all measurements are accurate before drilling holes to prevent misalignment of the accessories.

Toilet Roll Holder Installation (Right Hand)

Note: Our toilet paper holder is designed for versatility, allowing the rod to be installed with either left-hand or right-hand opening.

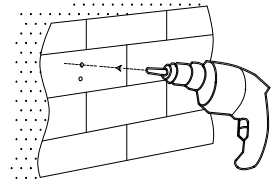
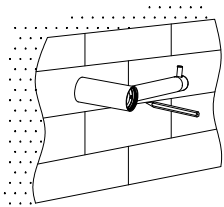

1. Unscrew the cover from the toilet roll holder. Place the toilet paper holder in the desired installation position as shown. Mark the center of the mounting bracket through the support with a marking pen.

2. Use an electric drill with a 6mm drill bit to drill holes at the marked points.

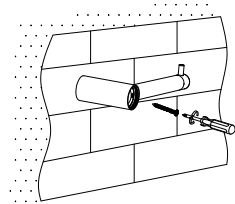
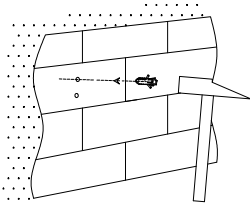

3. Insert the expansion plugs into the drilled holes using a hammer.

4. Drill the expansion screws into the pre-drilled holes.

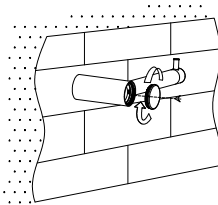

5. Screw on the cover of the toilet roll holder.

Toilet Roll Holder Installation (Left Hand)

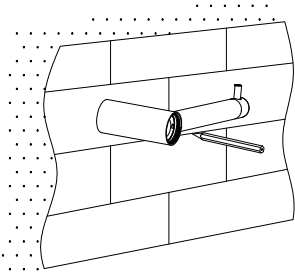

1. Place the towel bar in the desired installation position. Use a level to ensure the towel bar is horizontal. Mark the positions directly below the bases with a marking pen.

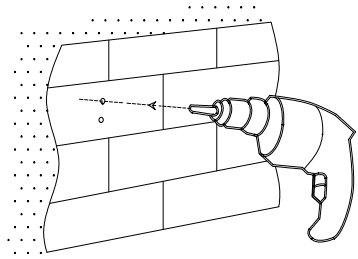

2. Position the fixing blocks at the marked spots. Mark the drilling points through the fixing block holes.

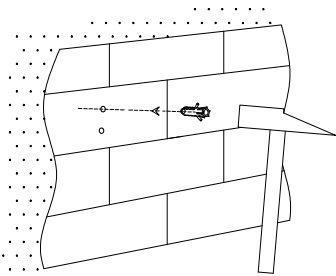

3. Use an electric drill with a 6mm drill bit to drill holes at the marked points.

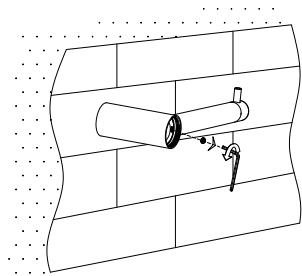

4. Remove the rod of the toilet roll holder by unscrewing the grub screw.

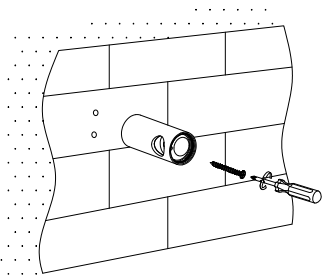

5. Position the rod bracket hole to the left and secure the bracket with expansion screws, as shown in the image.

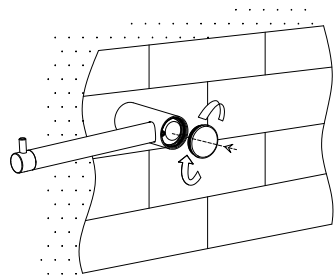

6. Install the rod of the toilet roll holder by tightening the grub screw, and screw on the cap.